



SANBOS[®] Waterclear
An efficient and cost-effective
water treatment system for
aqua-culture

Aquaculture, the most growing market sector

About 1.0 billion human beings worldwide depend on fish as their primary means of animal protein, particularly in coastal areas where reliance on fish is normally higher. The growing prices and availability of cheap wild fish has decreased considerably, and aquaculture fish has emerged as a good substitute to inland capture fish. The exponential growth of global populace is fueling the market growth of cultured fisheries, particularly in the affluent developed countries. Market growth of seafood is playing an instrumental role in narrowing the gap between supply and demand for these products. However, market for aquaculture products is being challenged by environmental concerns in addition to economical and social challenges. In the future the export of products from fisheries and aquaculture from Asia and Latin America into European Community will be possible just when meet the requirements for quality and price.

The success of breeding farms depends on several factors, such as:

- Farm design
- Climate conditions
- Feed plan and quality
- Water management and quality
- Health management.

Hereby the water quality is most important parameter which influences the growth and health of animals significantly. The content of dissolved oxygen in the water is responsible for keep alive the animals as well as remove toxic contents, such as ammonia, nitrate, organic matters, sludge layers, etc.

In intensive prawn farming and fish systems accumulation of feed residues, faeces, organic matter and toxic inorganic nitrogen is inevitable. Excretions released into the water become entrained in complex water chemistry processes which can result in excessive levels of dissolved and particulate nutrients (nitrogen and phosphorus are the most important). This in turn can exacerbate algal and bacterial blooms in the pond and lead to unstable water chemistry, with subsequent stress on the prawns.

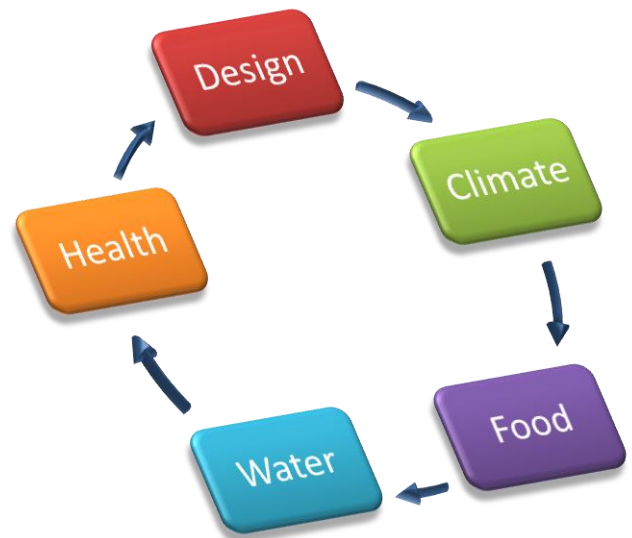

Factors for success in aquafarming

Water quality management is the key for success



SANBOS® Waterclear for aquaculture

SANBOS Waterclear concept for aquaculture is focused on water management to ensure high water quality with high performance, low energy demand and low costs.

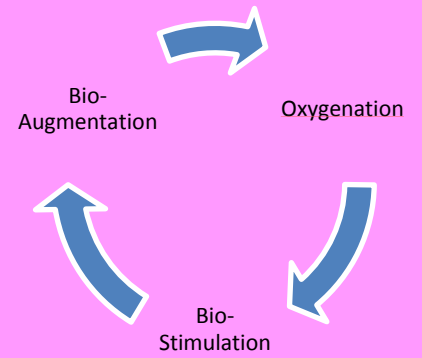
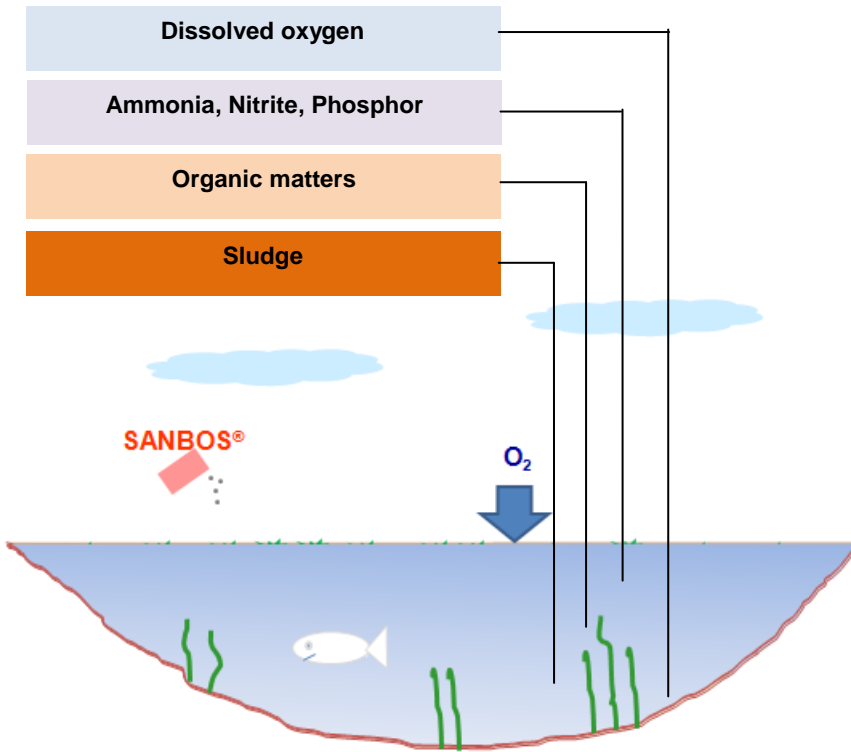

SANBOS® OXYGENATOR

High performance micro-bubble oxygenation system for high efficient mixing and aerating with very low energy
Integrated product of SANBOS Waterclear Technology

SANBOS® NUTRI

High performance microbiological treatment for nutrient removal and modern water management
Integrated product of SANBOS Waterclear Technology

Water quality management is the key for success

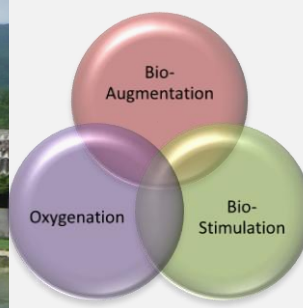

Aeration set-up

Pond aerators and water movers play a critical role in setting up a desirable culture environment for prawns in large ponds. They are primarily used to maintain adequate oxygen levels and gaseous exchange. They also keep the pond water column well mixed and prevent stratification so that the water quality is consistent throughout the pond.

Poor layout of aerators in the pond can lead to erosion of the pond walls or floor and significantly increase the amount of sediment in the sludge mound by the end of the crop. This can decrease the life span of your ponds and increase maintenance costs.



Poor aerator layout increases operating costs



Function of multi-step micro-bubble aeration system

Advantages

- High oxygen input due to micro-bubbles
- Gentle mixing avoid injury of prawns and fry
- No clogging
- Very low power consumption
- Easy to install
- Mobile design for flexible handling
- Independently operation for high safety and redundancy
- Robust and long-standing equipment



Ready for installation

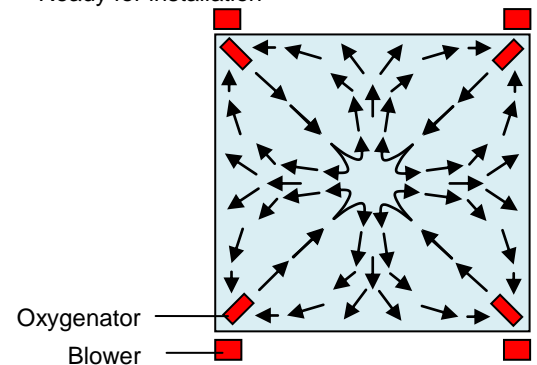

Typical installation of four independently operating sets installed into one pond with 10000 m² surface

80% less power consumption

compared to conventional aeration system, e.g. paddle aerators, standard bubble systems or venture systems

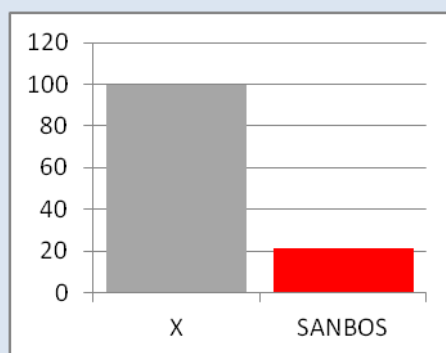

The complete system

Description

Complete system for oxygenation and introduction of water with dissolved oxygen, gently moving of water body as well as mixing of un-aerated and aerated water in natural and man-made ponds and generation of soft targeted stream.

One standard set consist of following technical components:

Micro bubble oxygenator	Pc	1
Stream booster	Pc	1
High performance blower	Pc	1
Fixing plate	Pc	1
Air supply hose	M	10
Fixing kit	Set	1
User manual	Set	1

4 Sets are suitable for one 10.000 m² pond.

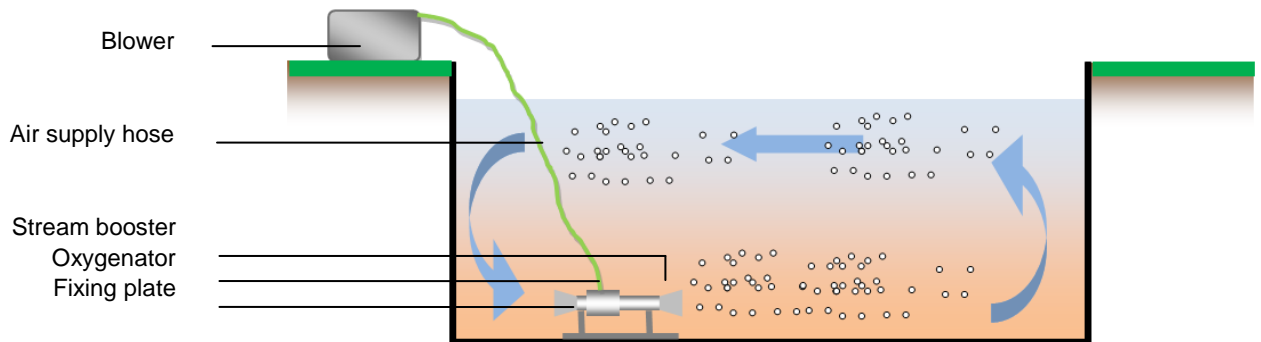
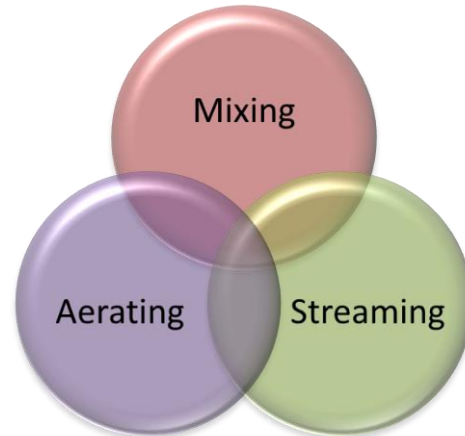

Multi purpose device



Oxygenator

Features

- Suitable for permanent operation
- Micro-bubble injection

Model	Unit	SB250 TURBO
Performance	m ² surface	3000
Depth	m	4
Oxygen input	grO ₂ /d	5000
Dimension	LxWxH mm	~ 1500x500x500
Power	W	270
Voltage	V	230



Special ceramic material used in injection chamber to produce micro bubbles



Stream booster

Features

- Gently stream boosting
- Suitable for permanent operation
- Stainless steel protection grit and pipe connection

Voltage	V	230
Power	W	160
Speed	RPM	1400
Flow	M3	29
Connection	mm	70
Net weight	Kg	12

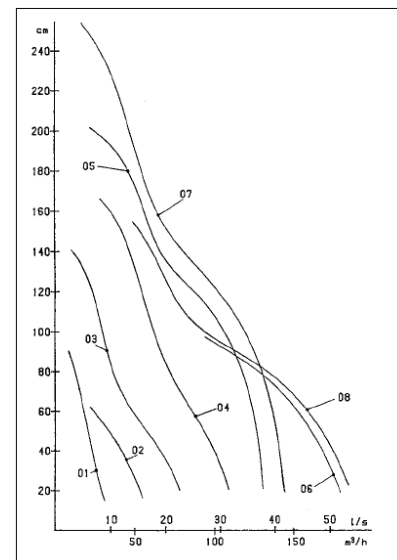

Diagram of engine operation point



High performance blower

Features

- Intergated overload protection
- Emergency protection switcher
- Low noise

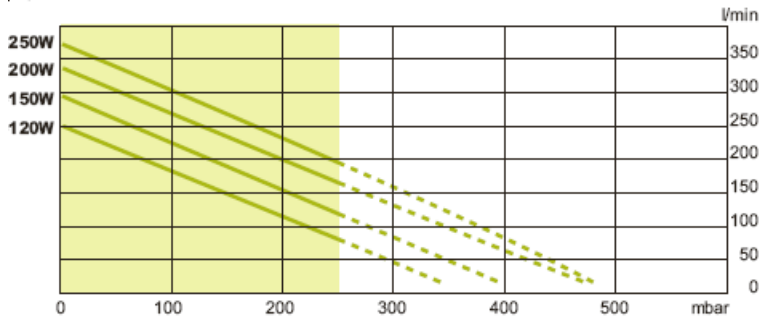
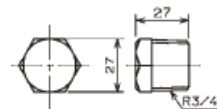
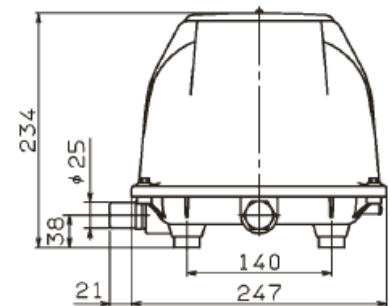
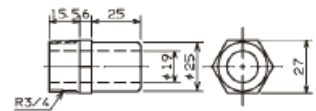
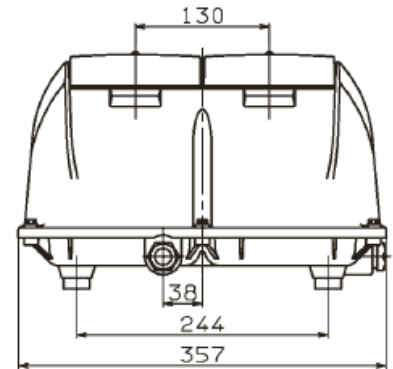

Diagram of engine operation point



Indoor installation



Outdoor installation

Model	Unit	250W	
Air flow	l/min	0 mbar	360
		50 mbar	320
		100 mbar	290
		150 mbar	262
		200 mbar	233
		250 mbar	205
Voltage	V	230	
Power	W	241	
Noise	dB(A)	55	
Dimension	mm	LxWxH	268.5 x 357 x 234
Connection	mm	25	
Net weight	Kg	16	



Installation at a fishfarm



SANBOS[®] NUTRI

SANBOS[®] NUTRI is a synergistic blend of natural high performance microorganisms (*Bacillus*) that maintains water quality during the crop cycle, degrades organic bottom wastes, and effectively controls the phytoplankton bloom. Maintaining a stable phytoplankton bloom and most suitable water quality during the crop cycle is of paramount importance for successful pond aquaculture. A well-maintained pond will provide higher yields and lower FCR, and will result in a crop less prone to disease.

High ammonia and nitrite levels cause acute and chronic effects that reduce the shrimp's disease resistance, stunt growth, and dramatically impact yield. These substances deteriorate water quality, increase the blood pH of the animal, reduce the oxygen content in the blood, cause stress to the animal by affecting its gills, and increase the mortality rate.

Benefits

Stable bloom: A propriety strain in SANBOS[®] NUTRI ensures a stable bloom throughout the crop cycle

Clean bottom: Unique strains selected for their ability to work at low oxygen levels digest bottom sludge and excess feed – keeping the bottom clean

Water quality: Improves water quality at all – remove ammonia, nitrate, BOD/COD, organic matter

Enhanced yield: By ensuring an optimal and stress-free environment, survival is increased and the feeding rate is improved, resulting in lower FCR and enhanced yields

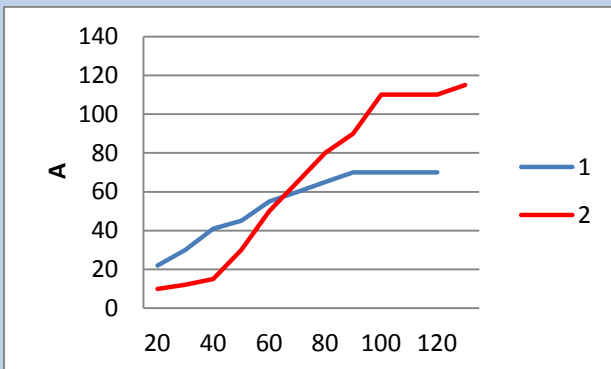
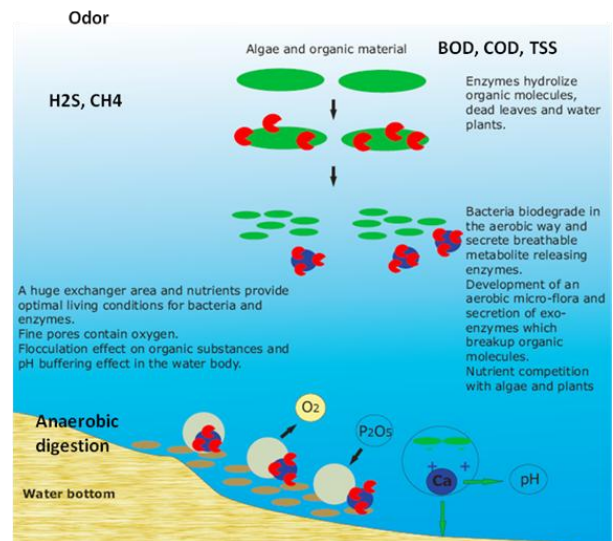

A=Daily feeding rate kg/Feed
1=Control 2=Treated

The daily feeding rate is an important indication of the crops general health. With the use of SANBOS[®] NUTRI water quality is maintained, providing a stress free environment throughout the culture cycle. The result is a steady increase in the feeding rate until harvest, indicating a healthy and growing crop. In the non-treated pond, the feeding rate stagnates after 70–90 days, indicating stress and slow growth.

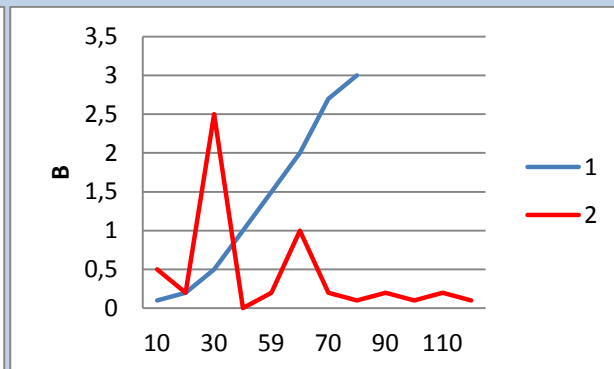

B=Ammonia and Nitrite level reduction
1=Control 2=Treated

The graphs show the toxic buildup of ammonia and nitrite in the non-treated (control) pond with advancing culture days. However, in ponds treated with SANBOS[®] NUTRI, ammonia and nitrite levels remained relatively low. The NH₃ and NO₂ peaks in the non-treated ponds were serious enough to cause mortality of the culture and force early harvest. Treated ponds had longer breeding period than non-treated ponds.

Dosage

Apply 1-2 kg SANBOS[®] NUTRI per 10.000 m² monthly or on demand.

Package

22 water soluble pouches, total 10kg per set



